

DESIGN AND DEVELOPMENT OF BATTERY CHARGER FOR ELECTRIC VEHICLE

THE REPORT OF PROJECT SUBMITTED FOR PARTIAL FULFILLMENT OF THE REQUIREMENT FOR THE DEGREE OF

*BACHELOR OF TECHNOLOGY
In
ELECTRICAL ENGINEERING*

By

AVIDIP DEY

**REGISTRATION NO – 201170101620002
UNIVERSITY ROLL NO – 11701620034**

DEBASIS INDU

**REGISTRATION NO – 201170101620010
UNIVERSITY ROLL NO – 11701620026**

SANDIP SEN

**REGISTRATION NO – 201170101620006
UNIVERSITY ROLL NO – 11701620030**

UNDER THE SUPERVISION OF

**Mr. SUBHASIS BANDOPADHYAY
Assistant Professor of Dept. of Electrical Engineering, RCCIIT**



AT
RCC INSTITUTE OF INFORMATION TECHNOLOGY
[Affiliated to Maulana Abul Kalam Azad University of Technology (MAKAUT), West
Bengal, India]
CANAL SOUTH ROAD, BELIAGHATA, KOLKATA – 700 015

© 2023

A close-up photograph of a person's hand holding a black and grey electric vehicle charging cable. The cable has an orange charging head. The background is blurred, showing what appears to be a charging station and a white car. The text is overlaid on the lower-left portion of the image.

"Unleash the full potential of your electric vehicle with our high-performance battery charger, fuelling your journey towards a greener tomorrow."

RCC INSTITUTE OF INFORMATION TECHNOLOGY

KOLKATA – 700015, INDIA



CERTIFICATE

The report of the Project titled Design and development of battery charger for electric vehicle submitted by Avidip Dey (Roll No.:11701620034 of B. Tech. (EE) 8th Semester), Debasis Indu (Roll No.:11701620026 of B. Tech. (EE) 8th Semester), Sandip Sen (Roll No.:11701620030 of B. Tech. (EE) 8th Semester) of 2023, has been prepared under our supervision for the partial fulfilment of the requirements for B Tech (EE) degree in Maulana Abul Kalam Azad University of Technology (MAKAUT), West Bengal, India
The report is hereby forwarded.

Mr. SUBHASIS BANDOPADHYAY
Assistant Professor, Dept. of Electrical Engineering
RCCIIT, Kolkata
(Internal Supervisor)

Countersigned by

.....
Dr. Shilpi Bhattacharya Deb
HOD (Electrical Engineering)
RCC Institute of Information Technology, Kolkata – 700 015, India

ACKNOWLEDGEMENT

We express our sincere gratitude to Mentor Assistant Professor Mr. Subhasis Banerjee of Department of Electrical Engineering, RCCIIT and for extending their valuable times for me to take up this problem as a Project.

We are also indebted to other faculty members for their unconditional help and inspiration.

Last but not the least we would like to express my gratitude to Dr. Shilpi Bhattacharya Deb, head of our department who helped us in their own way whenever needed.

Date:

Avidip Dey

Reg. No.: 201170101620002

Roll No.:11701620034

B. Tech (EE) – 8th Semester, 2023, RCCIIT

Debasis Indu

Reg. No.: 201170101620010

Roll No.:11701620026

B. Tech (EE) – 8th Semester, 2023, RCCIIT

Sandip Sen

Reg. No.: 201170101620006

Roll No.:11701620030

B. Tech (EE) – 8th Semester, 2023, RCCIIT

RCC INSTITUTE OF INFORMATION TECHNOLOGY
KOLKATA – 700015, INDIA



CERTIFICATE of ACCEPTANCE

The report of the Project titled Design and development of battery charger for electric vehicle submitted by Avidip Dey (Roll No.: 11701620034 of B. Tech. (2020-2023) 8th Semester), Debasis Indu (Roll No.:11701620026 of B. Tech. (EE) 8th Semester), Sandip Sen (Roll No.:11701620030 of B. Tech. (EE) 8th Semester) of 2023 is hereby recommended to be accepted for the partial fulfilment of the requirements for B Tech (EE) degree in Maulana Abul Kalam Azad University of Technology (MAKAUT), West Bengal, India.

Name of the Examiner

Signature with Date

1.

.....

2.

.....

3.

.....

4.

.....

TABLE OF CONTENTS**Topics Page No.**

1. Introduction	8
2. Review of Literature	9
3. Problem Analysis	10
4. Formulation / Algorithm	11
5. Problem Discussion	12
6. Implementation Details	13
7. Implementation of Problem	15
8. Sample Output	16
9. Conclusion / Future Scope of Work	18
10. Reference	20
11. Appendix A	21
12. Appendix B	27
13. Appendix C	29

ABSTRACT

Customers currently do not favour electric vehicles (EVs) very much since they must look for quick charging stations, wait in long lines to recharge their batteries, and find it challenging to find a suitable charging port. As a result, AC/DC charging can offer incredible benefits over plug-in charging. The fundamental goal of the introduction of electric vehicles was to establish a form of transportation that conserved energy, but in nations with a coal-based economy, like India, this idea fails. This is because the majority of the electricity generated in these nations comes from coal, which indirectly causes electric vehicles to produce the same amount of pollution as vehicles with internal combustion engines. Electric vehicle charging using solar energy is being implemented to ensure that the vehicles are energy efficient. This paper's primary goal is to introduce the advance charging system prototype for energy-efficient electric vehicles. In this work, wired charging for 48 volts is discussed. DC-DC Buck Converter is used to run the system at high frequency and voltage. Battery chargers for a variety of devices, such as electric vehicles, robots, inverters, and renewable energy sources, use DC-DC buck converters. In this study, a buck converter was constructed, and its controller was created using phase lag for the voltage loop and peak current control mode for the current loop. In order to create a nominal model based on the tiny signal technique, this research provides a formulation of plant disturbance caused by load variation. When compared to traditional models, the largest performance variation was determined to be 16%. The efficiency of the primary and secondary compensation circuits when charging the battery was also calculated, and it was found to be 48%. Solar energy and electric vehicles are key terms.

Keywords: **Electric Vehicle, Charging system, solar energy, EV battery charger.**

1. INTRODUCTION

In recent years, there has been a significant shift towards sustainable transportation, with electric vehicles (EVs) emerging as a promising solution. As the popularity of EVs continues to grow, the demand for efficient and reliable battery chargers has increased substantially. Designing and developing electric vehicle battery chargers requires a deep understanding of the complex requirements and challenges associated with this rapidly evolving technology.

The primary objective of an electric vehicle battery charger is to efficiently recharge the EV's battery pack, enabling extended driving ranges and reducing dependence on fossil fuels. To achieve this, the charger must meet several crucial design considerations, including safety, charging speed, compatibility, and user-friendliness.

Safety is of utmost importance in the design and development of EV battery chargers. These devices handle high-voltage electricity, and any flaws or malfunctions could pose significant risks to users and their surroundings. Implementing robust safety mechanisms, such as overcurrent and overvoltage protection, insulation monitoring, and fault detection, is vital to ensure the safe operation of the charger.

Charging speed is another critical aspect that impacts the overall user experience and the practicality of EVs. Drivers expect fast and convenient charging solutions, and charger designers strive to optimize charging efficiency without compromising safety. The charger's power electronics, including the AC-DC conversion stage and DC-DC conversion stage, must be carefully designed to minimize energy losses and maximize charging speed.

Compatibility is also a key consideration in charger design. EVs come in various models and configurations, each with its specific charging requirements. Designers must ensure that the charger supports the appropriate charging standards, such as the widely adopted Combined Charging System (CCS) or the CHAdeMO protocol, to cater to a broad range of electric vehicles and ensure seamless interoperability.

User-friendliness is a crucial factor in the widespread adoption of EVs. Designing intuitive user interfaces, incorporating smart features like wireless connectivity, and enabling remote monitoring and control are essential aspects of charger development. The goal is to provide a hassle-free and convenient charging experience for EV owners, enabling them to manage and monitor their charging sessions effortlessly.

In conclusion, designing and developing electric vehicle battery chargers requires a comprehensive understanding of safety requirements, charging speed optimization, compatibility with various EV models, and user-friendly features. As the electric vehicle market continues to grow, advancements in charger technology will play a vital role in promoting the widespread adoption of EVs and driving the transition towards a sustainable future of transportation.

2. LITERATURE SURVEY

Design and development of electric vehicle battery chargers is an active area of research and development, with many studies focused on improving the efficiency, safety, and reliability of these devices. A literature survey of this topic reveals a wide range of research and development efforts, including studies focused on charger topologies, control strategies, and testing methods.

One of the key challenges in designing electric vehicle battery chargers is achieving high efficiency while also maintaining safety and reliability. Many researchers have explored the use of different charger topologies to achieve these goals. For example, in a study published in the IEEE Transactions on Industrial Electronics in 2018, researchers proposed a high-frequency LLC resonant converter topology for a bidirectional charger for electric vehicles. The proposed converter achieved high efficiency, low electromagnetic interference, and reduced component count compared to traditional charger topologies.

Control strategies are also an important area of research in the design and development of electric vehicle battery chargers. Many studies have focused on developing advanced control algorithms to improve the efficiency and performance of chargers. For example, in a study published in the Journal of Power Sources in 2019, researchers proposed a fuzzy-logic-based control strategy for a battery charger for electric vehicles. The proposed strategy improved the charging efficiency and reduced the charging time compared to conventional charging methods.

In addition to charger topologies and control strategies, testing methods are also an important area of research in the design and development of electric vehicle battery chargers. Many researchers have proposed new testing methods to evaluate the performance and safety of chargers. For example, in a study published in the Journal of Energy Storage in 2020, researchers proposed a testing method based on a hardware-in-the-loop simulation to evaluate the performance of a bidirectional charger for electric vehicles. The proposed testing method was found to be effective in evaluating the charging performance and stability of the charger.

Overall, the literature survey reveals that the design and development of electric vehicle battery chargers is an active area of research and development, with many studies focused on improving the efficiency, safety, and reliability of these devices. Further research is needed to continue to advance the field and address the challenges associated with designing and developing electric vehicle battery chargers.

3. *Problem Analysis*

Designing and developing electric vehicle (EV) battery chargers specifically for scooters and small vehicles operating at 24 volts pose unique challenges and considerations. Let's analyze the key problems associated with this specific context:

- 1. Charging Speed and Efficiency:** Achieving optimal charging speed while maintaining efficiency is a critical challenge. Scooters and small vehicles often have limited battery capacity compared to larger EVs. Designing chargers that can efficiently and effectively charge these smaller batteries within a reasonable time frame is crucial. Balancing charging speed with heat dissipation, thermal management, and power delivery is a challenge.
 - 2. Size and Portability:** Scooters and small vehicles prioritize compactness and portability. Therefore, charger design must consider space constraints and aim for a small form factor. The charger should be lightweight and easily portable, allowing users to conveniently carry it with them. Achieving a balance between size, weight, and charging capabilities is a challenge.
 - 3. Connector Compatibility:** Different scooter and small vehicle models may use different charging connectors. Ensuring the charger supports the specific connector type used by the target vehicles is essential. Common connector types for smaller vehicles include barrel connectors, Anderson Powerpole connectors, or proprietary connectors specific to the manufacturer. Ensuring compatibility with various connector types adds complexity to charger design.
 - 4. Safety and Battery Protection:** Safety is a paramount concern when designing EV battery chargers. Implementing appropriate safety features to protect the battery, the charger, and the user is critical. Overcurrent protection, overvoltage protection, short-circuit protection, and temperature monitoring are important aspects to consider. Ensuring proper insulation, grounding, and electrical protection is necessary to meet safety standards and regulations.
 - 5. Cost-Effectiveness:** Affordability is a significant factor for scooter and small vehicle owners. Designing chargers that strike a balance between cost and quality is essential. Identifying cost-effective components and manufacturing processes without compromising safety, reliability, and performance is a challenge. Balancing affordability with the features and capabilities required for efficient charging is crucial.
 - 6. User-Friendly Interface and Experience:** Providing a user-friendly charging experience is important for the convenience and adoption of electric scooters and small vehicles. Designing chargers with intuitive interfaces, LED indicators for charging status, and possibly smart features like wireless connectivity or mobile apps enhances the user experience. Ensuring simplicity in operation and minimizing any complexities is important for widespread usability.
 - 7. Durability and Reliability:** Electric scooters and small vehicles are often used for daily commuting and short trips, making charger reliability crucial. The charger should be designed to withstand regular usage, potential environmental factors (such as moisture or temperature variations), and mechanical stresses. Ensuring long-term durability and reliability is essential for customer satisfaction and reducing the need for frequent repairs or replacements.
- Addressing these problems requires a deep understanding of the specific requirements and limitations of scooters and small vehicles operating at 24 volts. Collaboration among charger manufacturers, scooter manufacturers, and regulatory bodies is essential to define standards and guidelines for charger design. By overcoming these challenges, efficient, safe, and user-friendly EV battery chargers can be developed, facilitating the widespread adoption of electric scooters and small vehicles as sustainable transportation options.

4. FORMULATION / ALGORITHM

Theory/Block Diagram/Circuit Diagrams, Model /Figures & Images of Prototypes

In this circuit, the AC 230V to 24V 2Amp transformer steps down the main voltage. This input AC voltage is then rectified by the 10-ampere diode bridge. Furthermore, the 2200 μ F 50V capacitor utilizes to filter the noise and other agents from the source voltage, and the other two 0.33 μ F and 10 μ F capacitors are deployed for signal decoupling.

The LM7824 is a positive voltage regulator IC it gives direct 24V DC output, the yield current of that IC should not be more than 1.5 amperes thusly a TIP2955 transistor utilizes to enhance the output current to 2A. Using reasonable heat sinks with the IC and transistor increases the thermal stability of the circuit.

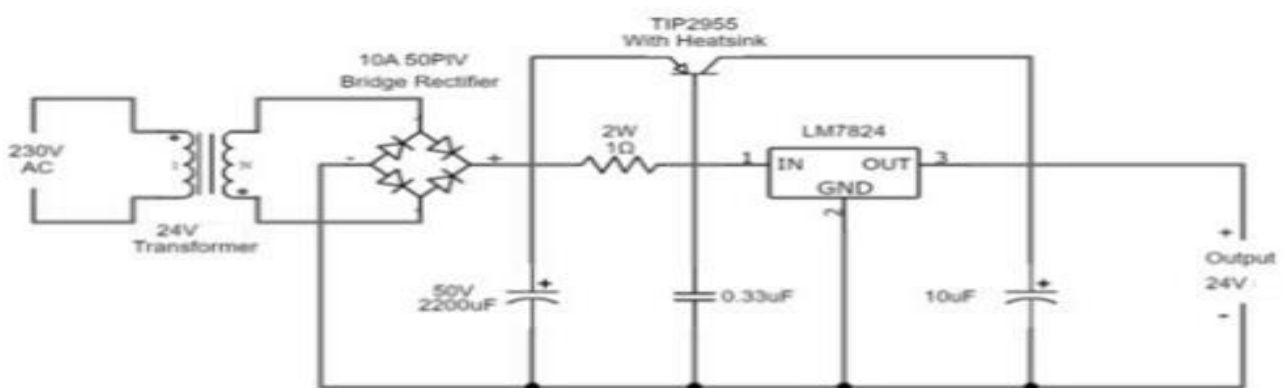

(a) Rectifier circuit

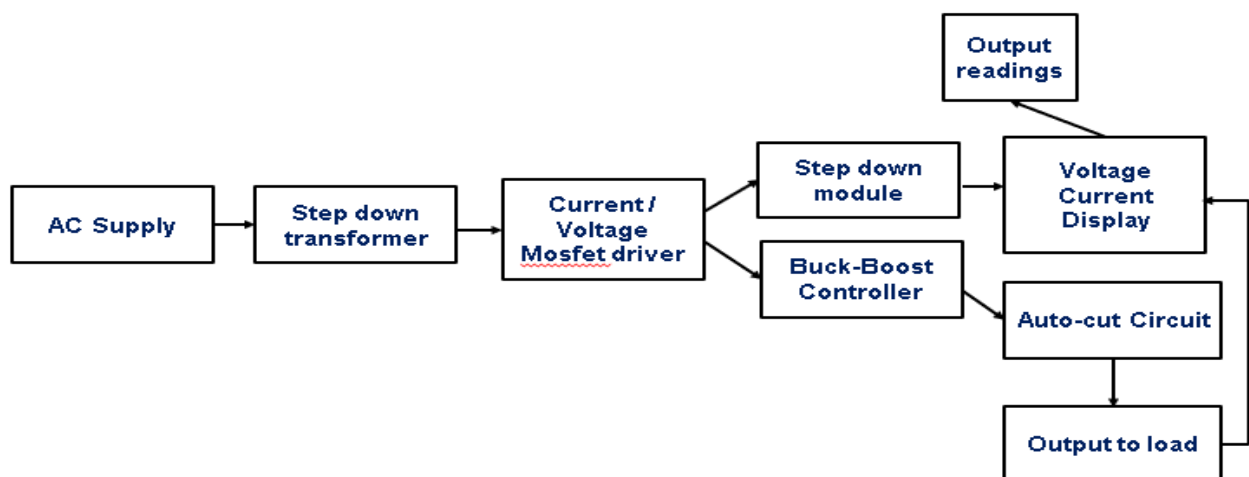

(b) Block diagram of overall system

5. **PROBLEM DISCUSSION**

Designing and developing electric vehicle battery chargers specifically for scooters and small vehicles that operate at 24 volts pose unique challenges and considerations. These challenges arise due to the specific characteristics and requirements of these vehicles. Let's discuss some key problems associated with designing and developing chargers for scooters and small vehicles:

- 1. Charging Speed and Battery Capacity:** Scooters and small vehicles typically have smaller battery capacities compared to larger electric vehicles. Designing chargers that can efficiently charge these batteries within a reasonable time frame is crucial. Optimizing charging speed while considering the limitations of the battery's charging capability and managing heat dissipation is a challenge.
- 2. Size and Portability:** Scooters and small vehicles often prioritize portability and compactness. Therefore, charger design should take into account space constraints and aim for a small form factor. Ensuring that the charger is lightweight and easily portable, allowing users to conveniently carry it with them, is an important consideration.
- 3. Safety and Battery Protection:** Safety is of utmost importance in charger design for scooters and small vehicles. Implementing appropriate safety features, such as overcurrent protection, overvoltage protection, and temperature monitoring, is critical to safeguarding the battery and preventing any potential hazards. Balancing safety with the compact form factor of the charger presents a challenge.
- 4. Durability and Reliability:** Scooters and small vehicles are often used for daily commuting and short trips, making charger reliability crucial. The charger should be designed to withstand regular usage, potential environmental factors (such as moisture or temperature variations), and mechanical stresses to ensure long-term durability and reliability.
- 5. Cost-Effectiveness:** Affordability is a significant factor for scooter and small vehicle owners. Designing chargers that strike a balance between cost and quality is essential. Identifying cost-effective components and manufacturing processes without compromising on safety and reliability is a challenge that needs to be addressed.
- 6. User-Friendly Interface and Charging Experience:** Providing a user-friendly charging experience is crucial for the convenience and adoption of electric scooters and small vehicles. Designing chargers with intuitive interfaces, LED indicators for charging status, and possibly smart features like wireless connectivity or mobile apps enhances the user experience. Ensuring simplicity in operation and minimizing any complexities is important for widespread usability.
- 7. Flexibility and Compatibility:** Scooters and small vehicles may come with different charging connector types and communication protocols. Designing chargers that can accommodate a variety of connectors and support relevant standards ensures compatibility with various scooter models. Flexibility in charging voltage and current options adds to the versatility of the charger.

Addressing these problems requires a thorough understanding of the specific requirements and limitations of scooters and small vehicles operating at 24 volts.

6. IMPLEMENTATION DETAILS

TECHNOLOGIES AND METHODOLOGIES USED IN ELECTRIC VEHICLE CHARGER

A. Rectifier

A rectifier is an electronic device that converts an alternating current into a direct current by using one or more P-N junction diodes. A diode behaves as a one-way valve that allows current to flow in a single direction. This process is known as rectification. A rectifier can take the shape of several physical forms such as solid-state diodes, vacuum tube diodes, mercury-arc valves, silicon-controlled rectifiers, and various other silicon-based semiconductor switches.

B. Buck Converter

DC-DC buck converters are used for battery chargers in many applications including renewable energy sources, inverters, electric vehicles, and robots. In this paper a buck converter was built, and its controller was developed using peak current control mode for current loop and phase lag for voltage loop. This paper proposes a formulation of plant disturbance due to load variation to obtain a nominal model based on small signal approach. The controller was derived analytically based on the nominal model. Experiment results show that the buck control system functions well in regulating the output voltage.

Buck Converter has many advantages compared to other DC DC converters. This can be used in low voltage vehicles like E-bikes (Hybrid Bicycle & Low CC Motor Bike), E-rickshaws etc. For Solar energy charging stations, we can use buck regulator for smooth flow of energy between PV and DC link. Different converters based on buck were present to improve power supply available to EV during charging.

C. DC-DC converter with battery controller

DC-DC converters are high-frequency power conversion circuits that use high-frequency switching and inductors, transformers, and capacitors to smooth out switching noise into regulated DC voltages. Closed feedback loops maintain constant voltage output even when changing input voltages and output currents.

D. Battery Switching Control

The control of battery charging, and discharging is based on two PI controllers:

one is for reference current generation (dependant on mode of operation: charging or discharging).

The other is for Current control of battery. The presented case study includes two modes of operation:

☑ Charging mode: automatically activated when DC bus is connected and the control objective i.e.: set point (of the 1st PI closed loop) becomes the full voltage of battery.

☑ Discharging mode: automatically activated when DC bus is NOT connected, and the control objective (of the 1st PI closed loop) becomes load voltage in order the maintain a constant load voltage during discharging.

E. Battery

A battery is a device that converts chemical energy contained within its active materials directly into electric energy by means of an electrochemical oxidation-reduction (redox) reaction. This type of reaction involves the transfer of electrons from one material to another via an electric circuit. While the term battery is often used the cell is the actual electrochemical unit used to generate or store electric energy.

F. PV arrays

The term solar panel is used colloquially for a photo-voltaic (PV) module.

A PV module is an assembly of photovoltaic cells mounted in a framework for installation. Photo-voltaic cells use sunlight as a source of energy and generate direct current electricity. A collection of PV modules is called a PV Panel, and a system of Panels is an Array. Arrays of a photovoltaic system supply solar electricity to electrical equipment.

G. MPPT solar charge controller

The MPPT solar charge controller is one kind of DC/DC converter that can deliver the maximum power generated by the solar panel to the battery to store the charge. It is the most complex one among solar charge controllers. The MPPT solar charge controller mostly has only a charging part. That means, it only controls solar panels to battery charging. For load control, another device may require depending on the power system.

H. 10A DC-DC Step-down Adjustable Constant Voltage Module

1. Lithium battery (or lead accumulator) charge.
2. Vehicle – mounted power supply.
3. Low voltage system power supply.
4. 6v, 12v, 14v, 24v battery charge.
5. Low voltage power supply system.

I. LM2596S DC-DC Buck Converter Power Supply

1. Input voltage: 3-40v
2. Output voltage: 1.5-35v (Adjustable)
3. Output current: Rated current is 2A, Maximum 3A
4. Switching frequency: 150KHz
5. Operating temperature: Industrial grade (-40 to +85)
6. Conversion efficiency: 92% (Highest)

J. Digital Voltmeter (0-100V) and Ammeter (10A) Dual LED Voltage Current Measurement Module

The Digital Voltmeter (0-100V) and Ammeter (10A) Dual LED Voltage Current Measurement Module is an electronic measurement device that is designed to measure voltage and current simultaneously in a circuit. The module consists of two LED displays, one for voltage and one for current. The voltage measurement range is 0-100V, and the current measurement range is up to 10A.

To use the module, the positive and negative leads of the circuit must be connected to the voltage and current input terminals, respectively. The voltage and current readings will then be displayed on their corresponding LED displays.

The module also features a potentiometer that can be used to adjust the brightness of the LED displays. This allows the user to adjust the brightness according to their specific needs.

Overall, this Dual LED Voltage Current Measurement Module is a simple and easy-to-use tool for measuring voltage and current in a circuit. Its compact size and digital display make it ideal for use in a variety of applications, including electronics projects, hobbyist work, and educational settings.

7. IMPLEMENTATION OF PROBLEM

TECHNIQUES USED FOR REAL-LIFE IMPLEMENTATION AND WORKING OF EV BATTERY CHARGER

The charging infrastructure industry has aligned with a common standard called the Open Charge Point Interface (OCPI) protocol with this hierarchy for charging stations: location, electric vehicle supply equipment (EVSE) port, and connector. The Alternative Fuels Data Centre and the Station Locator use the following charging infrastructure definitions:

- A. **Station Location:** A station location is a site with one or more EVSE ports at the same address. Examples include a parking garage or a mall parking lot.
- B. **EVSE Port:** An EVSE port provides power to charge only one vehicle at a time even though it may have multiple connectors. The unit that houses EVSE ports is sometimes called a charging post, which can have one or more EVSE ports.
- C. **Connector:** A connector is what is plugged into a vehicle to charge it. Multiple connectors and connector types (such as CHAdeMO and CCS) can be available on one EVSE port, but only one vehicle will charge at a time. Connectors are sometimes called plugs.
- D. **Charging Equipment:** Charging equipment for PEVs is classified by the rate at which the batteries are charged. Charging times vary based on how depleted the battery is, how much energy it holds, the type of battery, and the type of charging equipment (e.g., charging level and power output). The charging time can range from less than 20 minutes to 20 hours or more, depending on these factors. Charging the growing number of PEVs in use requires a robust network of stations for both consumers and fleets.

8. SAMPLE OUTPUT

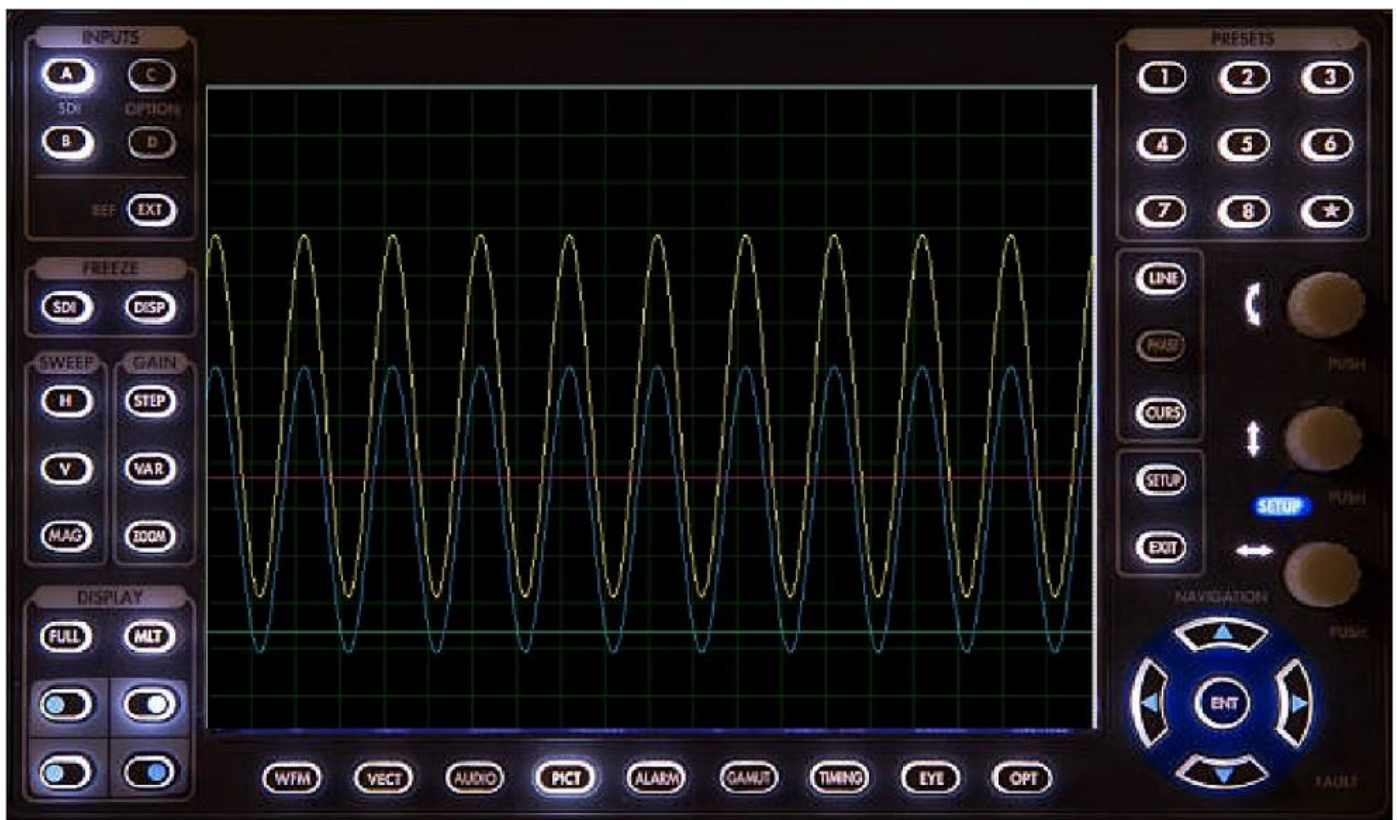

Measurement of Oscilloscope Waveforms

- Yellow Waveform - Input (Pure Sine Wave)**
- Blue Waveform - Output (At Transformer Terminal)**
- Red Waveform - Output (At Rectifier End)**
- Green Waveform - Across Load Terminal**

Benefits of electric vehicle

- **Cheaper expensive to operate:**

When compared to the cost of fuel to move a car of a same size a similar distance, the cost of electricity required to charge an EV is around 40% cheaper. The price will go down if you use your solar PV system or free charging stations to fill up your EV.

- **Less expensive to maintain:** Battery Electric Vehicles (BEVs) have fewer moving parts than regular gasoline or diesel-powered cars. Compared to a petrol or diesel vehicle, servicing is generally simpler, less frequent, and less expensive. Every EV battery ages (become less efficient). Most automakers guarantee that EV batteries won't deteriorate below a specific point for eight years or more. During the time you own an EV, a battery replacement may be required.
- **PHEVs, or plug-in hybrid electric vehicles:** They cost more to maintain than a BEV because they also feature gasoline or diesel engines that require maintenance.

More beneficial to the environment: -

- **Less pollution:** By opting for an EV, you may lessen the hazardous air pollution that comes from vehicle exhaust emissions. Even though an EV has no exhaust emissions, when it uses the power grid to charge, some greenhouse gas emissions are still produced.

- **Renewable energy:**

Having a solar PV system and charging your EV throughout the day will help you reduce your greenhouse gas emissions even further. An alternate choice is to purchase Green Power from your electrical supplier. Even if you recharge your EV from the electrical grid, the electricity you use after that is produced from renewable resources.

Better for our health: Lessening the dangers of exhaust emissions is good news for us. Less health issues and financial costs brought on by air pollution will result from better air quality. Additionally, EVs are quieter than gasoline and diesel vehicles, which reduces noise pollution.

- **Better for the network:** If EV charging is efficiently managed, especially outside of peak energy demand periods, it will aid us in creating a flatter electrical network demand profile over a typical 24-hour period. It will enable us to:
 - More effectively utilise the electrical network.
 - Assist EV owners in avoiding more expensive charging times.
 - Promote increased efficiency throughout the whole electricity system.
 - Assist in promoting the grid-wide integration of additional small- and large-scale renewable energy technologies.
- **Better for our energy security: -** Because it is simple to fuel EVs with local and renewable energy, reducing our reliance on oil. In the event that our nation's fuel supplies are ever interrupted or fuel prices rise considerably, EVs won't be impacted.

9. CONCLUSION / FUTURE SCOPE

This research paper developed a prototype model of wireless charging system which has remarkable advantages over the wired charging infrastructure and the most importantly the energy requirement for charging the vehicle will be supplied majorly through the renewable source of energy (i.e.) solar energy. The primary battery used in this model will be charged through solar energy.

The following conclusions have been made based on the contents of the paper: -

Charging the battery with solar energy until it reaches 90% SOC and eliminate the saturation stage would reduce the charging time about 12% to 15%. This technique would also reduce the stress on the battery and thus prolong the battery life span and reduce the emission produced due to charging of EV. The developed advanced charging system and its performance has been investigated and compared with the conventional models, the maximum variation has been found 16%, which is in close agreement between the advanced charger prototype and conventional charger to validate the prototype.

The future scope of designing and developing electric vehicle (EV) battery chargers for scooters and small vehicles operating at 24 volts is promising. As the demand for electric scooters and small EVs continues to rise, there are several areas of future development and innovation to consider:

Fast Charging Technology: The advancement of fast charging technology will significantly impact the charging experience for small EVs. Future chargers could incorporate technologies such as high-power charging, advanced cooling systems, and intelligent charging algorithms to minimize charging times and improve efficiency without compromising battery health.

Wireless Charging: Wireless charging technology has the potential to revolutionize the charging process for small EVs. Future chargers could utilize inductive or resonant wireless charging systems, allowing users to simply park their vehicles over a charging pad, eliminating the need for physical connectors. This would enhance convenience and reduce wear and tear on charging cables.

Vehicle-to-Grid (V2G) Integration: Small EVs, including scooters, can play a role in vehicle-to-grid integration. Future chargers could be designed to enable bidirectional power flow, allowing the EV battery to serve as a power source for the grid during peak demand periods. This would facilitate energy management and grid stability while providing potential financial benefits to EV owners.

Smart Charging Solutions: The integration of smart features into chargers for small EVs is an area of future development. These chargers could be equipped with connectivity options, such as Wi-Fi or cellular, enabling remote monitoring and control. Additionally, smart charging algorithms could optimize charging schedules based on electricity rates, grid conditions, and user preferences.

Energy Storage Integration: Small EV chargers could be designed to include energy storage capabilities, such as built-in batteries or ultracapacitors. This would allow the charger to store excess energy during low-demand periods and discharge it during high-demand or grid outage situations, reducing strain on the electrical grid and enhancing the overall energy efficiency of the charging infrastructure.

Improved User Interfaces and Mobile Applications: Enhancing the user experience through intuitive user interfaces and mobile applications is an ongoing area of improvement. Future chargers could feature touchscreens, voice control, or gesture-based interfaces, making them more user-friendly and interactive. Mobile applications could provide real-time charging status updates, remote control functionality, and personalized charging recommendations.

Sustainable Charging Solutions: As sustainability becomes increasingly important, future chargers for small EVs could prioritize renewable energy integration and eco-friendly charging options. This could include the ability to prioritize renewable energy sources, provide information on carbon emissions, and support smart grid integration for optimized green charging.

Standardization and Interoperability: Further standardization and harmonization of charging protocols, connector types, and communication standards will be crucial to ensure seamless interoperability between chargers and small EVs. Continued efforts in this area will facilitate a wider range of charging options and enhance the overall user experience.

The future scope of designing and developing electric vehicle battery chargers for scooters and small vehicles is characterized by innovation, improved charging technologies, enhanced user experiences, and a focus on sustainability. By addressing these areas, charger manufacturers can contribute to the growth and acceptance of small EVs, providing efficient and reliable charging solutions that cater to the evolving needs of users.

10. REFERENCE

- [1] <https://ieeexplore.ieee.org/document/8822448> DOI: [10.1109/JSYST.2019.2931880](https://doi.org/10.1109/JSYST.2019.2931880)
- [2] R. Piacentini, "Modernizing power grids with distributed intelligence and smart gridready instrumentation," in Proc. IEEE PES Innovative Smart Grid Technologies (ISGT), Washington, DC, 2012, pp. 1-6.
- [3] M. Yilmaz and P. T. Krein, "Review of Battery Charger Topologies, Charging Power Levels, and Infrastructure for Plug-In Electric and Hybrid Vehicles," IEEE Trans. Power Electronics, vol. 28, no. 5, pp. 2151-2169, May 2013.
- [4] O. Núñez-Mata, R. Palma-Behnke, F. Valencia, P. Mendoza-Araya and J. Cotos, "Integrated protection and monitoring system for safe operation of photovoltaic-based isolated microgrids," in Proc. IEEE Power & Energy Society General Meeting, 2017, pp. 1-5.
- [5] G.R.Chandra Mouli, P.Bauer, M.Zeman, ||System design for a electric vehicle charging station for workplaces,|| Applied Energy Volume 168, 15 April 2016.
- [6] Qahtan, M.H., Mohammed, E.A. and Ali, A.J. (2022) Charging Station of Electric Vehicle Based on IoT: A Review. Open Access Library Journal, 9, 1-22. doi: 10.4236/oalib.1108791.

Appendix A

(Hardware Description)

Transformer

A 220V to 24V step-down transformer is a type of electrical device that is designed to convert high-voltage alternating current (AC) power to low-voltage AC power. The transformer accomplishes this by using two coils of wire, called the primary and secondary coils, that are wrapped around a magnetic core. When AC power is applied to the primary coil, it creates a magnetic field that induces a voltage in the secondary coil, which is then stepped down to 24V.

This type of transformer is commonly used in electronic projects, where low-voltage power is required to operate electronic circuits, sensors, or other devices. The step-down transformer helps to isolate the low-voltage circuit from the high-voltage power source, ensuring safety and preventing damage to the circuit. It can also be used in industrial settings to power machinery or equipment that requires low-voltage power.

Product Details

Material	Alloy Steel
Grit Material	Copper, Steel
Item Dimensions L*W*H	40 x 40 x 40 Mllimetre's
Brand	ShivamTechnology
Compatible Material	Alloy Steel
Input Voltage	220 V, 50 Hz
Output Voltage	24v - 0v-24V
Output Current	5 Amp



Diode Bridge Rectifier

A diode bridge rectifier is an electrical circuit that converts alternating current (AC) to direct current (DC). In an electric vehicle, the diode bridge rectifier is used to convert the AC power from the vehicle's charging port to DC power that can be stored in the vehicle's battery. The diode bridge rectifier is made up of four diodes arranged in a bridge configuration, which allows the AC voltage to be rectified and converted to DC voltage. This conversion process is essential for the proper charging and operation of the electric vehicle.

Product Details

Nominal Current	10 A
Voltage Rating	1000V

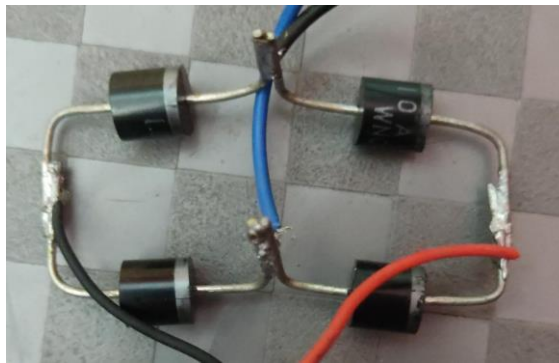

Battery Management System (BMS)

A Battery Management System (BMS) is an electronic system that monitors and controls the performance of a battery pack. In electric vehicles, the BMS is responsible for managing the charge and discharge of the battery, as well as ensuring that the cells are balanced and protected from overcharging or over-discharging.

An auto cut feature in a BMS is designed to prevent the battery pack from being damaged due to over-discharging. When the battery pack voltage drops below a certain level, the BMS will automatically disconnect the load from the battery, preventing further discharge.

An auto sense feature in a BMS is designed to detect the state of charge (SOC) and state of health (SOH) of the battery pack. This information is used to calculate the remaining range of the vehicle and to ensure that the battery pack is operating within safe limits.

Together, these features can help to extend the life of the battery pack and ensure that the electric vehicle is operating safely and efficiently.

Product Details

Input Supply voltage (V)	7 ~ 40
Output voltage (V)	continuously adjustable (1.25 ~ 35)
Output Current (A)	8A (10A maximum)
Conversion efficiency:	95%
Operating frequency (KHz)	300
No-load current	Typical 20mA
Load regulation	± 1%
Voltage Regulation	± 1%
Length (mm)	65
Width (mm)	47
Height (mm)	22
Weight (gm)	70

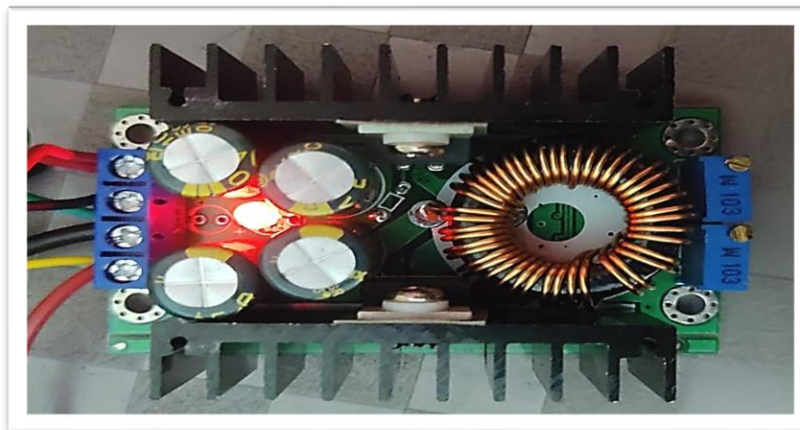

DC Step-Down Control Driver

A DC step-down control driver for an electric vehicle is an electronic circuit that regulates the voltage and current supplied to the vehicle's electrical system. This driver is designed to step down the high voltage DC power from the battery pack to a lower voltage that can be used by the vehicle's electrical components such as the motor, lights, and other electronics.

The DC step-down control driver typically consists of a DC-DC converter, which uses pulse-width modulation (PWM) to control the output voltage and current. The converter adjusts the duty cycle of the PWM signal to regulate the output voltage and current.

The control driver is an important component of an electric vehicle's powertrain system, as it ensures that the electrical components receive the correct voltage and current to operate efficiently and safely. By using a DC step-down control driver, the overall efficiency of the electric vehicle can be improved, leading to longer driving range and better performance.

Product Details

Wide Input voltage	3.5V-35V
Output Voltage	4-35V
Output current	Rated current 3A MAX
Conversion efficiency	Up to 92%
Switching Frequency	50KHz
Operating temperature	-40 to +85 C
Load regulation	± 0.5%
Voltage regulation	± 0.5%
Length(mm)	52
Width(mm)	22
Height(mm)	20
Weight(g)	13
Shipment Weight	0.017 kg

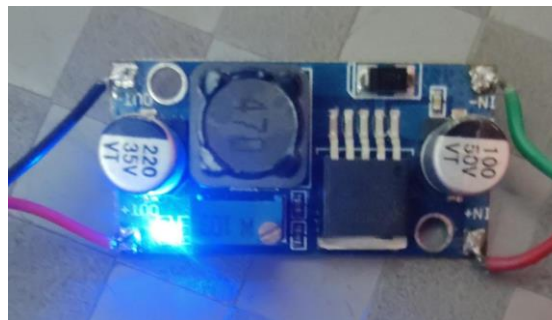

Digital Ammeter-Voltmeter

The DC 100V 100A LED Digital Ammeter-Voltmeter is an electronic device that can measure the current and voltage of an electric vehicle's battery system. This device is useful for monitoring the performance of the battery system, which is a critical component in an electric vehicle. The LED display provides easy-to-read digital readouts of the current and voltage values, and the device is compact and easy to install. This product could be used as part of a project appendix for an electric vehicle, providing a way to measure the performance of the battery system and make adjustments as needed to optimize efficiency and performance.

Product Details

Accuracy	1
Colour	Red and Blue
Operating Voltage (VDC)	5
Current Consumption (mA)	60
Testing Voltage (V)	0 to 100
Testing Current (A)	1 to 100
Refresh Speed (ms)	500 (one time)
Operating Temperature (°C)	-10 to 60
Height (mm)	30
Length (mm)	20
Width (mm)	50
Shunt Resistor Dimensions (mm)	120x25x20 (LxWxH)
Weight (gm)	14



Appendix B

(Project Operation)

Operation

A battery charger with auto cut and auto sense is an electronic device used to charge the batteries of electric vehicles. The charger works by converting AC power from a wall outlet into DC power that is suitable for charging the batteries.

The auto sense feature of the charger allows it to automatically detect the type and capacity of the battery being charged, and adjust the charging rate accordingly to avoid overcharging or damaging the battery. The charger also monitors the battery's temperature and adjusts the charging rate accordingly to prevent overheating.

The auto cut feature of the charger is designed to prevent overcharging of the battery. When the battery is fully charged, the charger automatically shuts off the charging process to prevent damage to the battery.

Overall, the battery charger with auto cut and auto sense is a safe and efficient way to charge electric vehicle batteries, ensuring that they are charged quickly and efficiently while avoiding any damage that could occur due to overcharging or overheating.

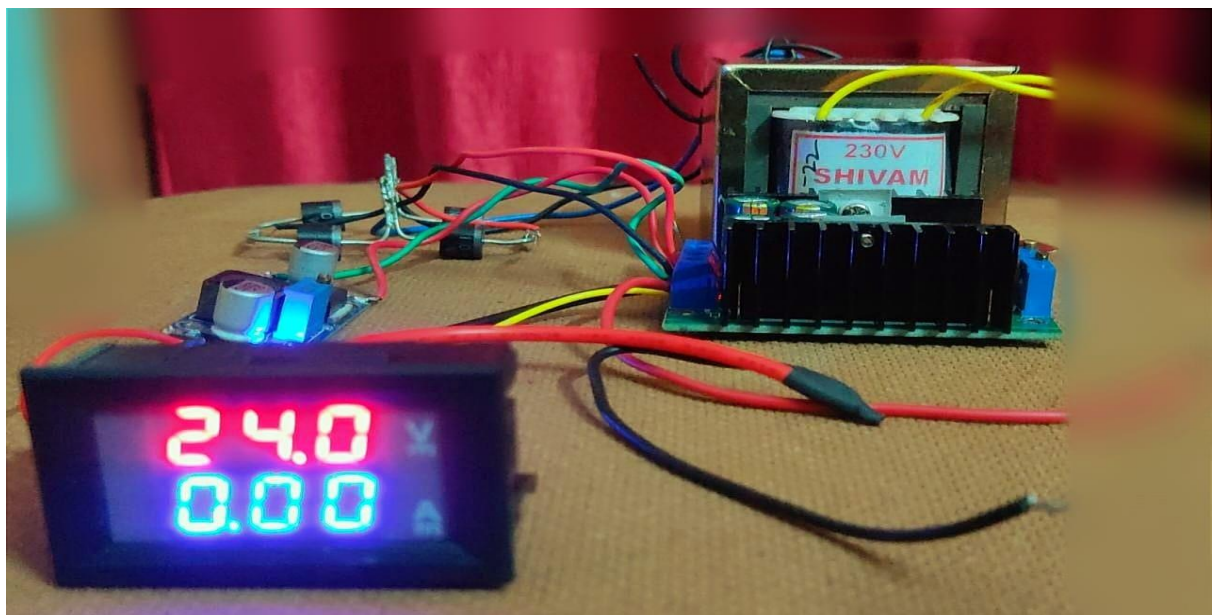

Appendix C

(Next-Gen EV Charger)

Revolutionizing EV Charging

The aim of this project is to design and develop an electric vehicle (EV) charger that is efficient, safe, and cost-effective. The charger incorporates several unique features that make it stand out from the local chargers available in the market.

One of the key features of this charger is the auto cut-off feature, which prevents overcharging of the battery and helps to extend its lifespan. The auto sense feature of the charger automatically detects the battery type and capacity and adjusts the charging rate accordingly, ensuring a safe and efficient charging process. Additionally, the charger includes a thermal shutdown feature that prevents overheating of the battery during the charging process.

This charger also offers a wide range of voltage settings to accommodate different battery packs, making it suitable for use with a variety of electric vehicles. Furthermore, the charger comes with a solar charging option connectivity, allowing it to harness energy from the sun and reduce reliance on traditional power sources.

With low power loss and a small and compact design, this charger is highly efficient and can be easily transported. It is also cost-effective, providing a long run for a low cost. Overall, this project offers a promising solution for electric vehicle owners who are looking for an efficient and safe charging option.